

LN Lighting technical data

LED LAMP 2W MR11

Lighting technical data

**LED MR11 is an alternative light source
with longer life and uniformed light distribution**



ROHS

LED LAMP MR11



Line-Up

Model No.	Watts(W)	Light Output(lm)	Dimension(mm)	Light Color(K)	Beam Angle(Degree)
LN-11-2W-D-AD-CW-00	2±10%	200±10%	Φ35*36.5	6000K	30
LN-11-2W-D-AD-WW-00		170±10%	Φ35*36.5	3000K	30
LN-11-2W-CD-AD-CW-00	2±10%	160±10%	Φ35*36.5	6000K	120
LN-11-2W-CD-AD-WW-00		130±10%	Φ35*36.5	3000K	120

Technical Specifications

Item	Test Conditions	Min.	Typ.	Max.
Input Voltage(V, rms)	AC	---	12	---
Input Current(mA, rms)	AC(12V)	---	167	---
Input Voltage(V, rms)	DC	10	12	30
Input Power(W, rms)	DC(All)	---	2	---
Input Frequency(Hz)	DC	---	20KHz	---
Power Factor(PF)	DC(All)	---		
Output Voltage(V)	DC	9	9.45	9.9
Output Current(mA)	DC	190	200	210
Output Power(W)	DC	1.71	1.89	2.079

Environmental Requirements

Specifications	Values
Operational Temperature Range	-20~40℃
Preservation Temperature Range	-20~90℃
Operational Humidity Range	95%Rh or below (@-20~40℃)
Installation Area	Indoor (Counter,Residential,Commercial,etc)

LED LAMP MR11



Drawing

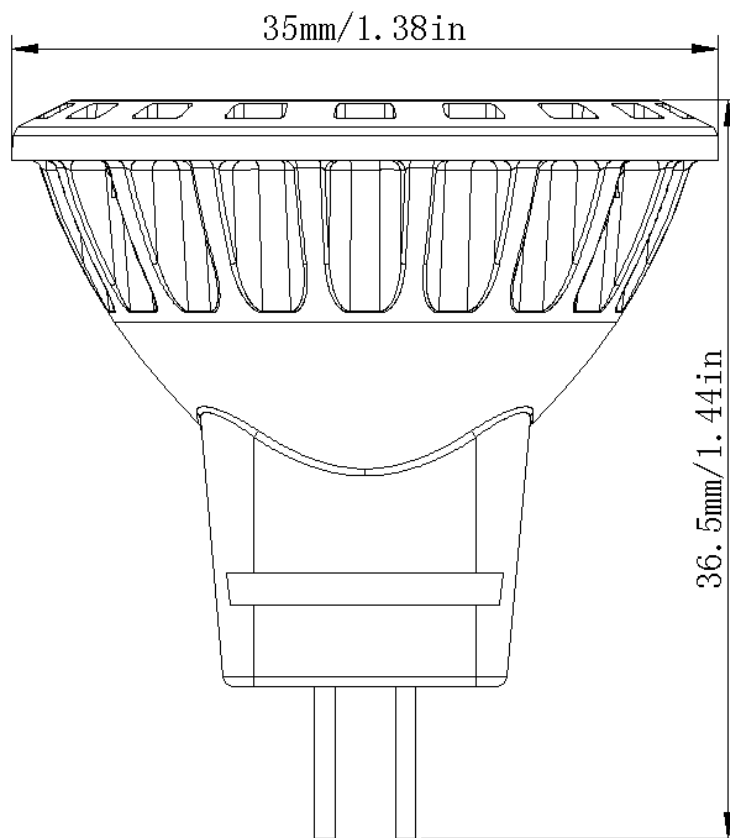

Material	IP
ADC12	20
PMMA/PC	

LED LAMP MR11



LN-11-2W-D-AD-CW-00

Category	Specifications	Unit
Watts	2	W
Lumens per Watt(Efficacy)	100	Lm/W
Light Output	200	lm
Light Color(CCT)	6000	K
Beam Angle	30	'(degree)
Color Accuracy(CRI)	80	Ra
Product Weight	16	G
Rating Life	35000	H
Base	GU4	
Input Voltage(DC/AC)	12	V

Luminance Intensity Distribution

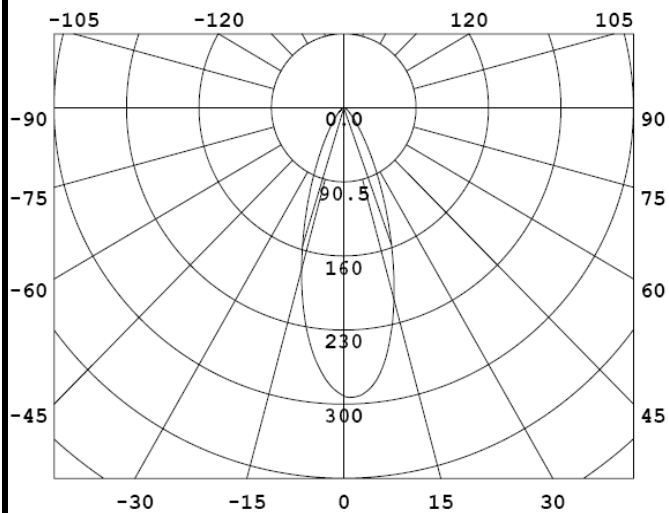

Cone Lux Diagram

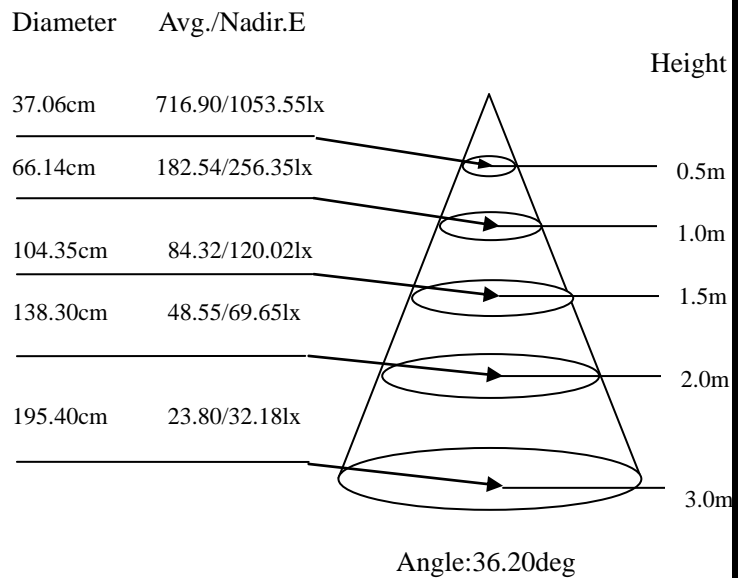

LED LAMP MR11



LN-11-2W-D-AD-WW-00

Category	Specifications	Unit
Watts	2	W
Lumens per Watt(Efficacy)	85	Lm/W
Light Output	170	lm
Light Color(CCT)	3000	K
Beam Angle	30	°(degree)
Color Accuracy(CRI)	80	Ra
Product Weight	16	G
Rating Life	35000	H
Base	GU4	
Input Voltage(DC/AC)	12	V

Luminance Intensity Distribution

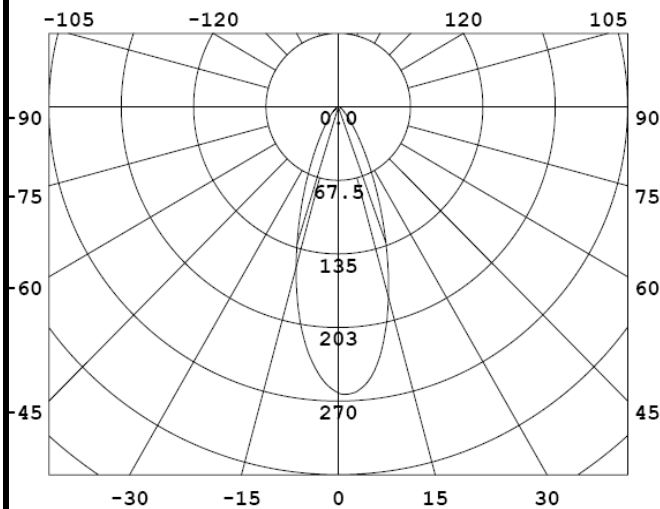

Cone Lux Diagram

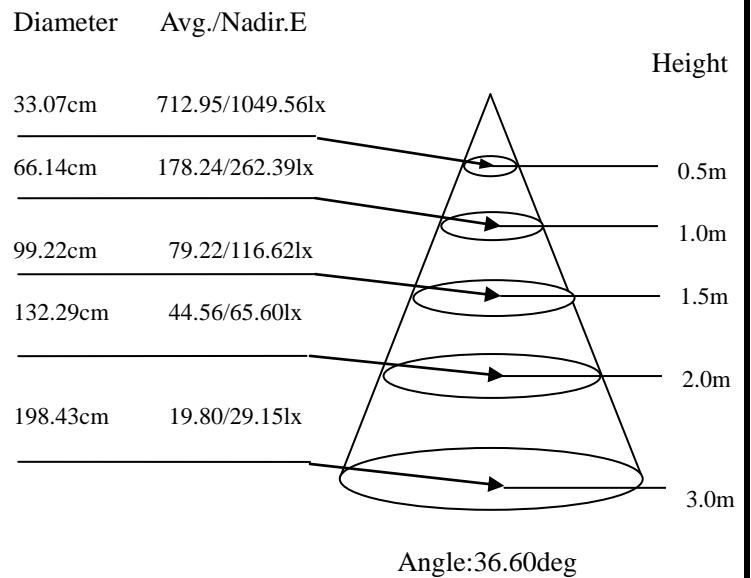

LED LAMP MR11



LN-11-2W-CD-AD-CW-00

Category	Specifications	Unit
Watts	2	W
Lumens per Watt(Efficacy)	80	Lm/W
Light Output	160	lm
Light Color(CCT)	6000	K
Beam Angle	120	°(degree)
Color Accuracy(CRI)	70	Ra
Product Weight	16	G
Rating Life	35000	H
Base	GU4	
Input Voltage(DC/AC)	12	V

Luminance Intensity Distribution

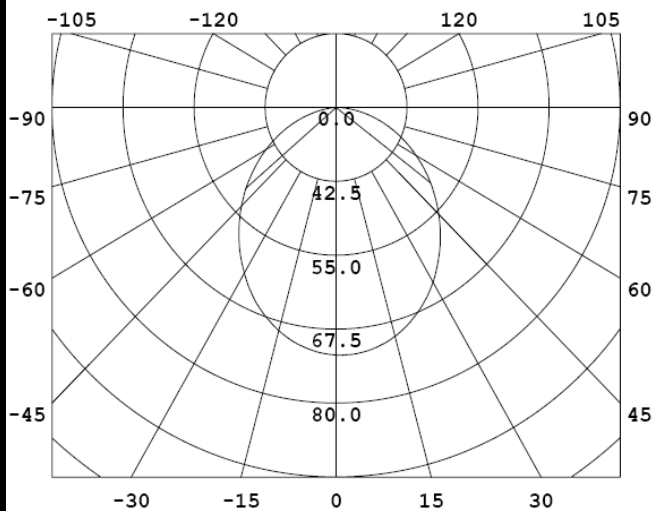

Cone Lux Diagram

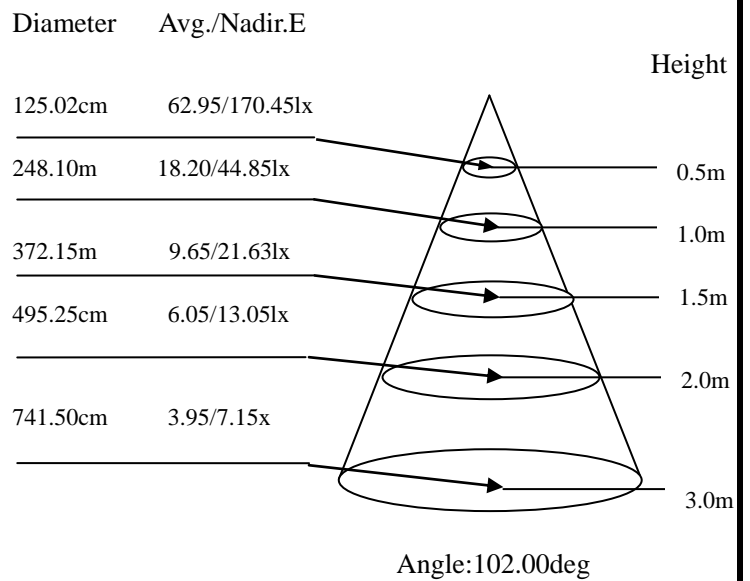

LED LAMP MR11



LN-11-2W-CD-AD-WW-00

Category	Specifications	Unit
Watts	2	W
Lumens per Watt(Efficacy)	65	Lm/W
Light Output	130	lm
Light Color(CCT)	3000	K
Beam Angle	120	° (degree)
Color Accuracy(CRI)	80	Ra
Product Weight	16	G
Rating Life	35000	H
Base	GU4	
Input Voltage(DC/AC)	12	V

Luminance Intensity Distribution

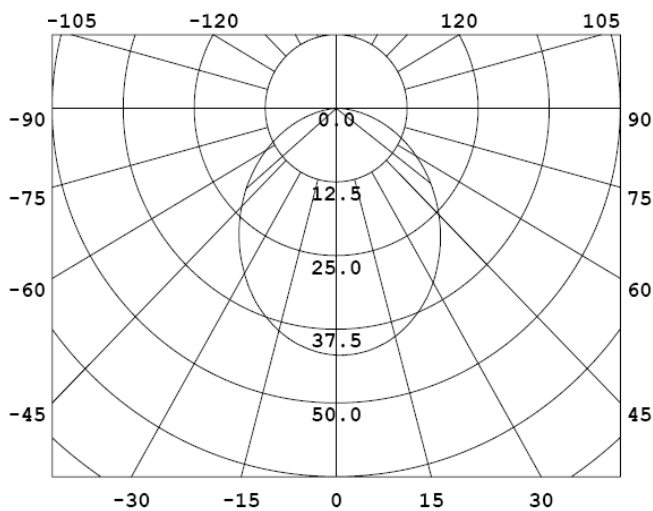

Cone Lux Diagram

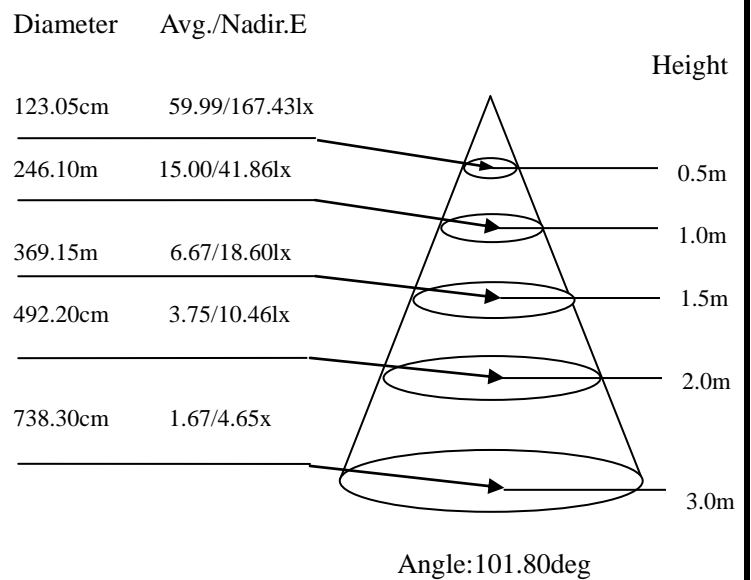

LED LAMP MR11



Product Packaging	Specifications	Unit
Product Dimension	Φ35*H36.5	mm
Net Weigh	0.016	Kg
Size of box	L37*W35*H35	mm
Gross Weight	0.02	Kg
Size of inner box	L290*W240*H90	mm
Qty/ box	70	PCS
Gross Weight	1.55	Kg
Size of Carton	L555*W330*H320mm	mm
Box/ Carton	8	PCS
Qty/ Carton	560	PCS
Weight/ Carton	13.65	Kg

Revision History

MTime	Changed to: VER	Description of Change		
		Item	From	To
2013-4-17	/	Issue	/	/